

FR Guide de l'utilisateur	CS Návod k použití	LV Lietošanas pamācība
EN User's guide	SK Používateľská príručka	BG Ръководство на потребителя
DE Bedienungsanleitung	PL Instrukcja obsługi	AR دليل الاستعمال
NL Gebruiksaanwijzing	CS Návod k použití	KO 사용자 가이드
ES Guía del usuario	SK Používateľská príručka	BA Korisnička uputstva
PT Guia del usuario	HU Használati útmutató	RC 使用指南
IT Manuale d'uso	SL Navodila za uporabnika	HK 使用指南
DA Brugsvejledning	RU Руководство пользователя	FA راهنمای کاربر
NO Bruksanvisning	UK Посібник користувача	VN Hướng dẫn dùng cho người sử dụng
SV Användarhandbok	HR Upute za uporabu	TH คู่มือสำหรับผู้ใช้งาน
FI Käyttöopas	RO Ghidul utilizatorului	SR Uputstvo za upotrebu
TR Kullanım kılavuzu	ET Kasutusjuhend	
EL Οδηγός χρήσης	LT Naudotojų vadovas	



FR Pour plus d'informations sur l'utilisation / **EN** For further usage information / **DE** Weitere Informationen zur Bedienung / **NL** Voor meer informatie over het gebruik / **ES** Para obtener más información sobre su uso / **PT** Para obter mais informações sobre a utilização / **IT** Per maggiori informazioni sull'utilizzo / **DA** Yderligere informationer vedrørende betjening / **NO** For mer informasjon om bruken / **SV** För mer information om användningen / **FI** Lisätietoja käyttöä varten / **TR** Kullanım hakkında daha fazla bilgi için / **EL** Για περισσότερες πληροφορίες σχετικά με τη χρήση / **PL** Więcej informacji na temat korzystania z urządzenia / **CS** Pro více informací o použití / **SK** Pre ďalšie informácie o používaní / **HU** A használatra vonatkozó további információk / **SL** Več informacij o uporabi / **RU** Для получения более подробной информации об эксплуатации / **UK** Для отримання детальнішої інформації щодо експлуатації / **HR** Za više informacija o upotrebi / **RO** Pentru mai multe informații privind utilizarea / **ET** Täiendava teabe saamiseks kasutamise kohta / **LT** Daugiau informacijos apie naudojimą / **LV** Lai iegūtu vairāk informācijas par lietošanu / **BG** За още информация относно употребата / **AR** للمزيد من المعلومات عن الاستعمال / **KO** 더 자세한 사용 정보: / **BA** Za više informacija o upotrebi: / **RC** 更多关于使用的信息: / **HK** 更多關於使用的資訊: / **FA** برای کسب اطلاعات بیشتر برای استفاده / **VN** Để biết thêm thông tin về cách sử dụng: / **TH** สำหรับข้อมูลเพิ่มเติมเกี่ยวกับการใช้งาน: / **SR** Za dodatne informacije o korišćenju

www.tefal.com  www.calor.fr

FV18xx

FR Veuillez lire attentivement le livret "Consignes de sécurité et d'utilisation" avant la première utilisation / **EN** Please read carefully the «Safety and use instructions» booklet before first use / **DE** Lesen Sie vor dem erstmaligen Gebrauch aufmerksam die Broschüre „Sicherheits- und Bedienungsanweisung“ durch. / **NL** Gelieve vóór het eerste gebruik aandachtig het boekje met de veiligheids- en gebruiksvorschriften door te nemen / **ES** Lea detenidamente el libro «Instrucciones de seguridad y de uso» antes de utilizar el aparato por primera vez / **PT** Leia atentamente o manual «Instruções de segurança e utilização» antes da primeira utilização / **IT** Leggere con attenzione il libretto «Norme di sicurezza e d'uso» al primo utilizzo / **DA** Læs hæftet «Sikkerheds- og brugsanvisning» grundigt igennem inden den første ibrugtagning. / **NO** Les nøye heftet «Råd om sikkerhet og bruk» før første gangs bruk / **SV** Var god läs häftet "Säkerhets- och användningsinstruktioner" innan den första användningen. / **FI** Lue turvallisuus- ja käyttöohjevihko huolellisesti ennen ensimmäistä käyttökertaa. / **TR** İlk kullanımdan önce «Güvenlik ve kullanım talimatları» kitapçığını dikkatlice okuyun / **EL** Διαβάστε προσεκτικά το εγχειρίδιο «Οδηγίες ασφαλείας και χρήσης» πριν από την πρώτη χρήση / **PL** Przed pierwszym użyciem proszę uważnie przeczytać broszurę „Zalecenia dotyczące bezpieczeństwa i użytkowania” / **CS** Před prvním použitím si, prosím, pečlivě prostudujte „Bezpečnostní pokyny pro použití” / **SK** Pred prvým použitím si pozorne prečítajte „Bezpečnostné odporúčania a použitie”. / **HU** Az első használat előtt figyelmesen olvassa el a „Biztonsági előírások és használati útmutató” című fejezetet / **SL** Pred prvo uporabo natančno preberite »Navodila za varno uporabo« / **RU** Перед первым использованием внимательно прочитайте инструкцию «Меры безопасности и правила использования». / **UK** Перед першим використанням уважно прочитайте посібник «Правила техніки безпеки та рекомендації щодо використання» / **HR** Molimo da prije prve uporabe pažljivo pročitate priručnik „Sigurnosne upute” / **RO** Înainte de prima utilizare, citiți cu atenție manualul „Instrucțiuni de siguranță și de utilizare” / **ET** Palun lugege enne esimest korda kasutamist hoolikalt ohutus- ja kasutusjuhendit / **LT** Atidžiai perskaitykite knygelę „Saugos ir naudojimo reikalavimai” prieš naudodami įrenginį pirmą kartą / **LV** Pirms izmantojat ierīci pirmoreiz, lūdzu rūpīgi izlasiet brošūru «Norādījumi par drošību un lietošanu» / **BG** Моля, прочетете внимателно книжката «Препоръки за безопасност и употреба» преди първоначална употреба / **AR** يرجى قراءة كتيب السلامة وإرشادات الاستعمال بعناية قبل الاستعمال للمرة الأولى / **KO** 처음 사용하기 전, 제품 사용과 관련된 <안전 수칙> 책자를 주의 깊게 읽어 주시기 바랍니다 / **BA** Molimo vas da prije prve upotrebe pročitate knjžicu «Uputstva za sigurnost i upotrebu» / **RC** 在第一次使用前请认真阅读此“安全操作规程”手册 / **HK** 在第一次使用前請認真閱讀此“安全操作規程”手冊 / **FA** قبل از اولین استفاده، لطفاً جزوه ایمنی و دستورالعمل استفاده را با دقت بخوانید / **VN** Vui lòng đọc kỹ cuốn «Hướng dẫn Sử dụng và Biện pháp An toàn» trước khi sử dụng lần đầu / **TH** กรุณาอ่านหนังสือคู่มือความปลอดภัยและการใช้งานก่อนการใช้งานครั้งแรก / **SR** pažljivo pročítajte priručnik „Uputstva o bezbednosti i korišćenju” pre prve upotrebe



TURBO

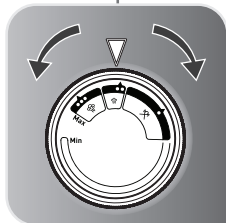
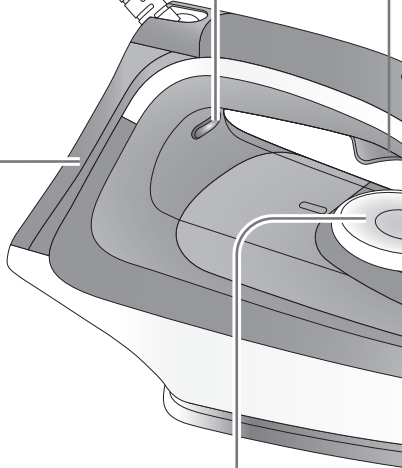
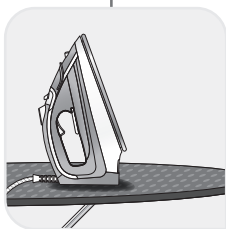
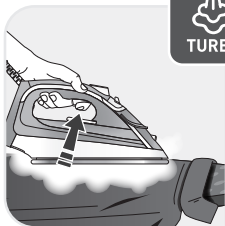
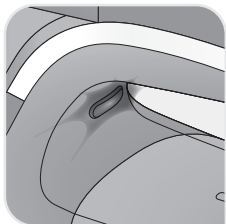

***FR** Selon modèle / **EN** Depending on model / **DE** Je nach Modell / **NL** Afhankelijk van het model / **ES** Según modelo / **PT** Consoante o modelo / **IT** Secondo i modelli / **DA** Afhængig af model / **NO** Avhenger av modell / **SV** Beroende på modell / **FI** Mallista riippuen / **TR** Modele göre / **EL** ανάλογα με το μοντέλο / **PL** W zależności od typu / **CS** Podle modelu / **SK** V závislosti od modelu / **HU** Modelltől függően / **SL** Odvisno od modela / **RU** В зависимости от модели / **UK** Залежно від моделі / **HR** Ovisno o mo delu / **RO** Ovisno o modelu / **ET** Sõltuvalt mudelist / **LT** Pagal modelį / **LV** Atbilstoši modelim / **BG** в зависимост от модела / **AR** حسب الموديل / **KO** 모델에 따라 다름 / **BA** Zavisno od modela / **RC** 视型号而定 / **HK** 視型號而定 / **FA** بسته به مدل / **VN** Theo mẫu / **TH** ตามรุ่น / **SR** U zavisnosti od modela

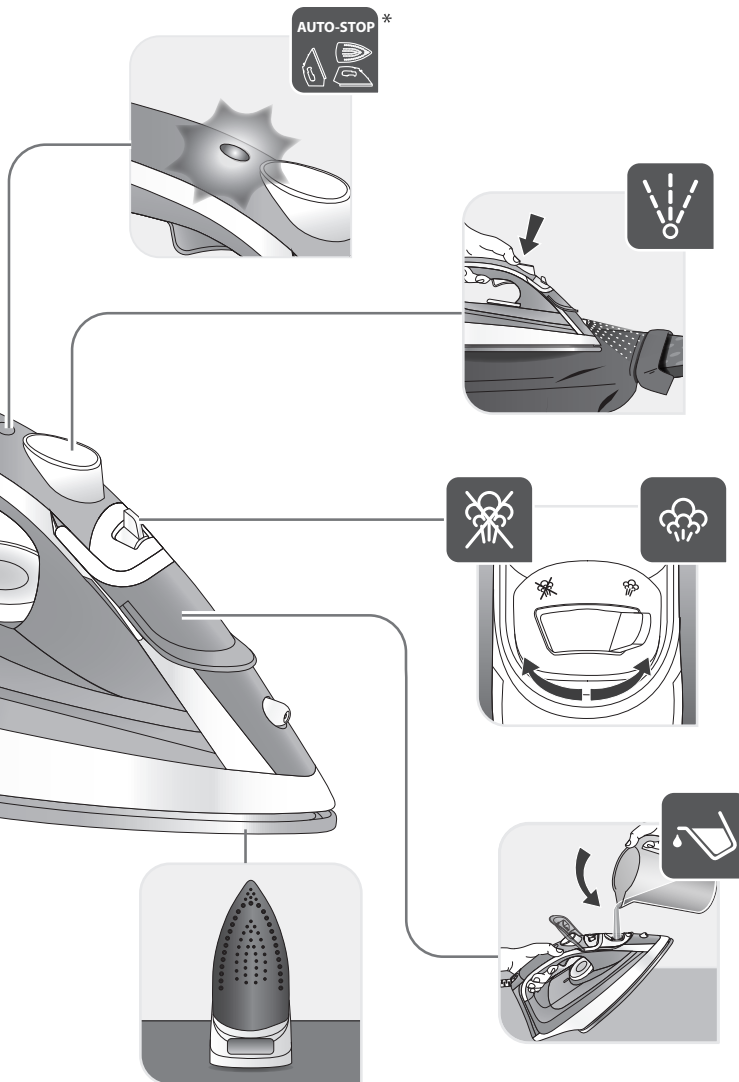

1.

www.tefal.com



www.calor.fr

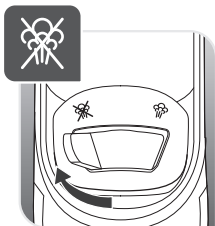

1.

www.tefal.com



www.calor.fr

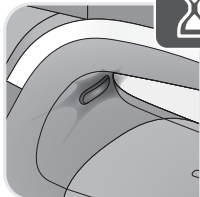
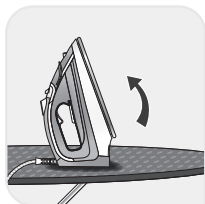
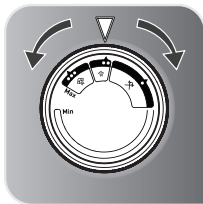
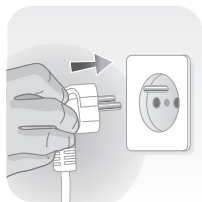
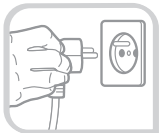

OK

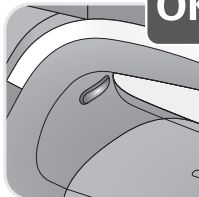

OK

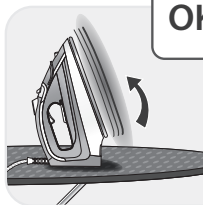

NO







2.

www.tefal.com

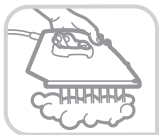

www.calor.fr

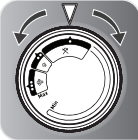
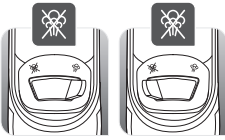
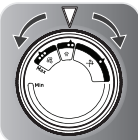
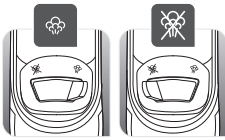

2.

www.tefal.com  www.color.fr

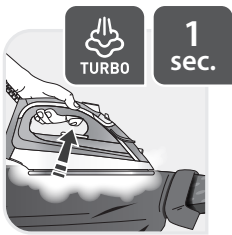
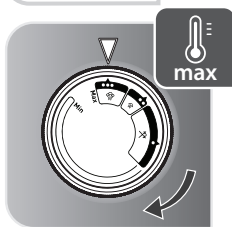
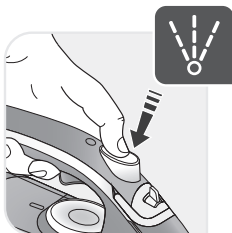

2.

www.tefal.com



www.calor.fr

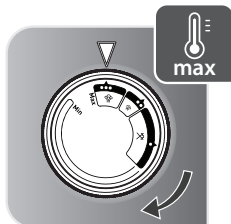

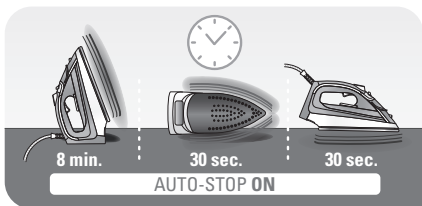
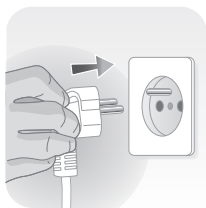

AUTO-STOP*

* **FR** Selon modèle / **EN** Depending on model / **DE** Je nach Modell / **NL** Afhankelijk van het model / **ES** Según modelo / **PT** Consoante o modelo / **IT** Secondo i modelli / **DA** Afhængig af model / **NO** Avhenger av modell / **SV** Beroende på modell / **FI** Mallista riippuen / **TR** Modele göre / **EL** ανάλογα με το μοντέλο / **PL** W zależności od typu / **CS** Podle modelu / **SK** V závislosti od modelu / **HU** Modelltől függően / **SL** Odvisno od modela / **RU** В зависимости от модели / **UK** Залежно від моделі / **HR** Ovisno o modelu / **RO** Ovisno o modelu / **ET** Sõltuvalt mudelist / **LT** Pagal modelį / **LV** Atbilstoši modelim / **BG** в зависимост от модела / **AR** حسب الموديل / **KO** 모델에 따라 다름 / **BA** Zavisno od modela / **RC** 視型号而定 / **HK** 視型號而定 / **FA** بسته به مدل / **VN** Theo mẫu / **TH** ตามรุ่น / **SR** U zavisnosti od modela

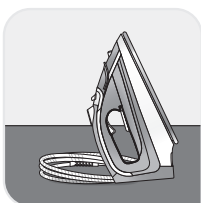
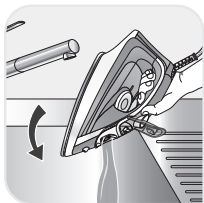
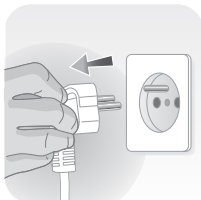
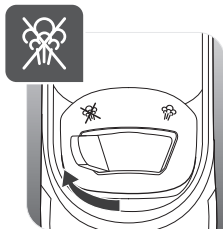

3.

www.tefal.com  www.calor.fr



3.

www.tefal.com  www.calor.fr



1H



3.

www.tefal.com  www.calor.fr

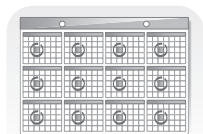

12X YEAR**

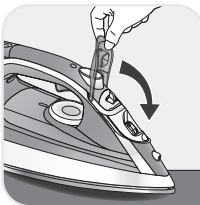
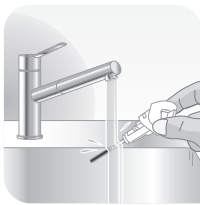
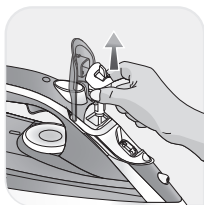
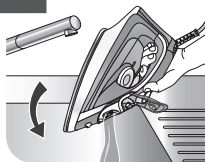

** FR An / EN Year / DE Jahr / NL Jaar / ES Año / PT Ano / IT Anno / DA år / NO år / SV år / FI x / TR yıl / EL έτος / PL Rok / CS Rok / SK rok / HU Év / SL Leto / RU Год / UK Рік / HR Godina / RO An / ET Aasta / LT Metai / LV Gads / BG година / AR عام / KO 년 / BA Godina / RC 新年 / HK 年 / FA سال / VN Năm / TH ปี / SR Godina

3.

www.tefal.com



www.calor.fr

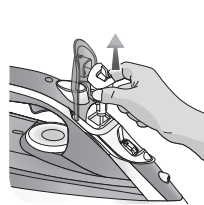
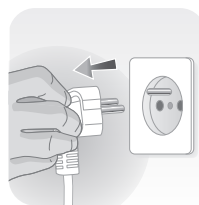
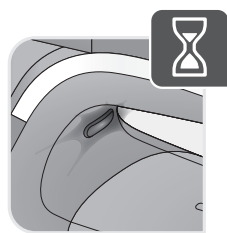
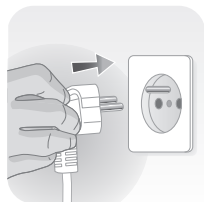
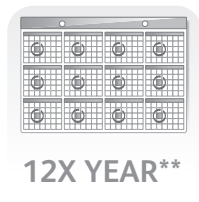

****** FR An / EN Year / DE Jahr / NL Jaar / ES Año / PT Ano / IT Anno / DA år / NO år / SV år / FI x / TR yıl / EL έτος / PL Rok / CS Rok / SK rok / HU Év / SL Leto / RU Год / UK Рік / HR Godina / RO An / ET Aasta / LT Metai / LV Gads / BG година / AR عام / KO 년 / BA Godina / RC 新年 / HK 年 / FA سال / VN Năm / TH ปี / SR Godina

3.

www.tefal.com  www.calor.fr

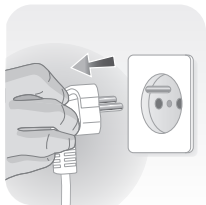
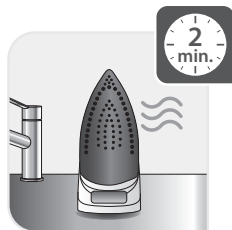
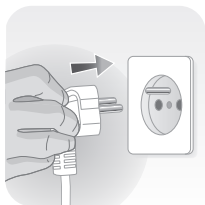
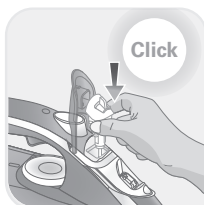

Утюги с пароувлажнителем бытовые Tefal FV18xxxx
где x – любая цифра от 0 до 9 и/или буква от A до Z
Изготовлено в Китае для холдинга "GROUPE SEB", France
(Groupe SEB, 112 Chemin du Moulin Carron 69130 Ecully, France)
Груп СЕБ, 112 Шмэн дю Мулен Каррон 69130 Экули Франс
Официальный представитель, импортер - ЗАО "Группа СЕБ-Восток"
125171, г. Москва, Ленинградское ш., д. 16А, стр. 3 тел. 8-495-213-32-32

Технические характеристики:

220-240 В 50-60 Гц 2100-2500 Ватт Класс I

Информация о сертификации:

- Сертификат соответствия № RU C-FR.AГ27.B.01033
- Срок действия с 26.01.2018 по 25.01.2023
- Выдан ОС ООО «ИНТЕРСТАНДАРТ»

Соответствуют требованиям:

- ТР ТС 004/2011 "О безопасности низковольтного оборудования", утв. Решением КТС от 16.08.2011г. №768.
- ТР ТС 020/2011 "Электромагнитная совместимость технических средств", утв. Решением КТС от 09.12.2011г. №879.

Срок службы изделия 2 года с даты продажи в условиях эксплуатации и хранения при температуре от 0°C до 40 °C



